



# SHEET METAL CONNECTORS, INC.

www.smduct.com

MINNEAPOLIS, MN  
5850 Main Street N.E.  
Minneapolis, Minnesota 55432  
LOCALLY CALL: 763-572-0000  
TOLL FREE: 1-800-328-1966  
FAX: 763-572-1100

ROCKFORD, IL  
5601 Sandy Hollow Road  
Rockford, Illinois 61109  
LOCALLY CALL: 815-874-4600  
TOLL FREE: 1-866-504-4600  
FAX: 815-874-9979



## 90° Register Saddle

Sheet Metal Connectors, Inc. PVC fittings and connections are fabricated in 4 x 1 or 4 x 4 material to protect against corrosion from soil. SMC PVC fittings are manufactured with an elbow lock seam or standing seam. SMC fabricates PVC fittings in most sizes and configurations using our state of the art equipment. All joints and connections should be sealed in accordance with SMC's recommendations to assure an air tight system.

### All PVC fittings can be manufactured with:

- E-Z Flange Jr. with Barrel Clamp - 6" to 24" Diameter
- E-Z Flange with Barrel Clamp - 26" to 96" Diameter
- Standard Spiral Slip Connector

Spiral pipe and fitting slip connector joints must be sealed to prevent air leakage and to keep dirt and sand out of the duct system. PVC Tape is recommended as it is ideal for this usage. It has superior adhesive qualities, even in extremely hot or extremely cold weather. Also as an insurance factor, PVC Duct Sealer No. 8 is available. This is a flexible and self-curing air pressure sealant. This can be applied from one-gallon cans by brush application. It provides a positive sealing of joints and screw holes. PVC Duct Sealer No. 8 may also be obtained in a cartridge package. Approximate coverage is 375 linear feet per gallon at a 1/4" bead.

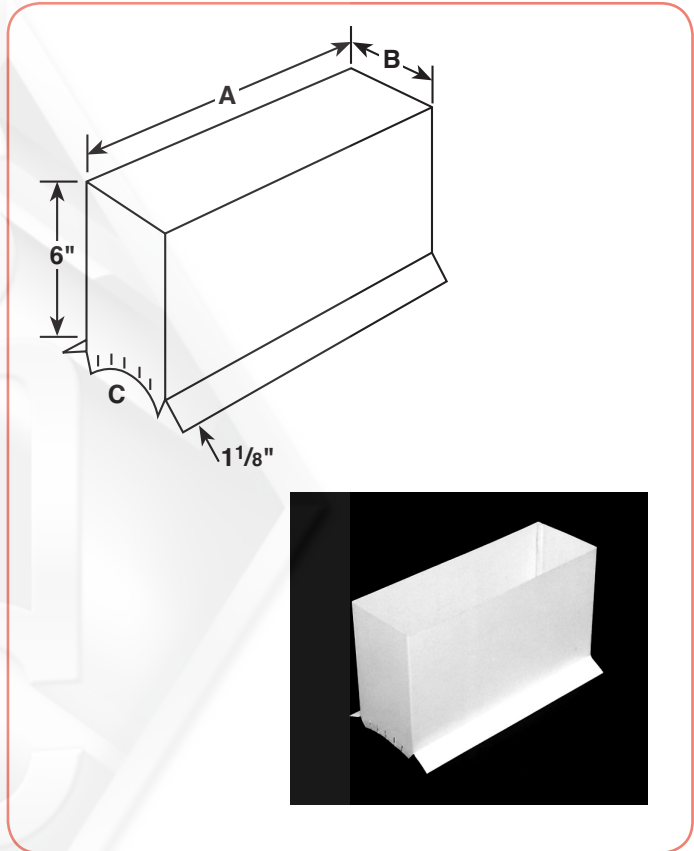

Dimensions to be listed as follows: A, B, C

